

DATASHEET

Variable Speed Drives



Main Features

Reference : CFW320B05P6T4DB20
 Product code : 17452680
 Product line : CFW320

Basic data

Power supply : 380-480 V
 Input minimum-maximum voltage : 323-528 V
 Input phases : Three-phase
 - Input : 3
 - Output : 3

	Range 1	Range 2
Supply voltage range	380-415 V	440-480 V
Overload regime	Heavy (HD)	Heavy (HD)
Rated current (HD)	5.6 A	5.6 A
Overload current for 60 s (HD)	9.8 A	8.4 A
Single-phase input current (HD) [1]	Not applicable	Not applicable
Three-phase / DC input current (HD) [1]	7.8 A	6.7 A

Maximum applicable motor:

Voltage/Frequency	Normal Overload (ND)	Heavy Overload (HD)
380V / 50Hz	Not applicable	4 / 3
380V / 60Hz	Not applicable	4 / 3
400V / 50Hz	Not applicable	4 / 3
400V / 60Hz	Not applicable	4 / 3
440V / 50Hz	Not applicable	4 / 3
440V / 60Hz	Not applicable	4 / 3
460V / 60Hz	Not applicable	4 / 3
480V / 60Hz	Not applicable	4 / 3

Dynamic braking [3] : Standard with braking
 External RFI filter : CFW320-KFB-T4
 Link Inductor : No
 Memory card : Not included in the product
 USB port : Yes, by CFW320-CUSB
 Line frequency : 50/60Hz
 Line frequency range (minimum - maximum) : 48-62 Hz
 Phase unbalance : Less or equal to 3% of input rated line voltage
 Transient voltage and overvoltage : Category III
 Typical input power factor : 0.83
 Displacement factor : 0.98
 Rated efficiency : $\geq 97\%$
 Maximum connections (power up cycles - on/off) per hour : 10 (1 each 6 minutes)
 DC power supply : Allow
 Switching frequency [4]: : 5 kHz
 Selectable switching frequency : 2.5 and 15 kHz
 Real-time clock : Not available
 Copy Function : Yes, by MMF-uDrives
 Dissipated power [5]: : 91 W

Source available to the user

Output voltage : 10 Vdc
 Maximum capacity : 50 mA

Control/performance data

Power supply : Switched-mode power supply
 Control method - induction motor : V/f (escalar) and VVW
 Encoder interface : Available With CFW320-IOAENC
 Control output frequency [5] : 0-400 Hz
 Frequency resolution : 0.1 Hz

V/F Control

- Speed regulation : 1% of rated speed
 - Speed variation : 1:20
 VVW Control
 - Speed regulation : 1% of rated speed
 - Speed variation : 1:30
 Sensorless vector control
 - Speed regulation : Not applicable

DATASHEET

Variable Speed Drives



V/F Control

- Speed variation : Not applicable
- Vector control with Encoder
- Speed regulation : Not applicable

Analog Inputs

- Quantity (standard) : 1
- Levels : 0-10V, 0-20mA and 4-20mA
- Impedance for voltage input : 100 kΩ
- Impedance for current input : 500 Ω
- Function : Programmable
- Maximum allowed voltage : 30 Vcc

Digital inputs

- Quantity (standard) : 4
- Activation : Active low and high
- Maximum low level : 5 V (low) and 10 V (high)
- Minimum high level : 10 V (low) and 20 V (high)
- Input current : 11 mA
- Maximum input current : 20 mA
- Function : Programmable
- Maximum allowed voltage : 30 Vcc

Analog outputs

- Quantity (standard) : Only with plug-in
- Levels : Not applicable
- RL for voltage output : Not applicable
- RL for current output : Not applicable
- Function : Not applicable

Digital outputs

- Quantity (standard) : 1 NO/NC relay
- Maximum voltage : 250 Vac
- Maximum current : 0.5 A
- Function : Programmable

Communication

- Modbus-RTU (with accessory: CFW300-CRS485, CFW300-CRS232, CFW300-CUSB or CFW300-CBLT)
- Modbus/TCP (with accessory: CFW300-CETH)
- Profibus DP (with accessory: CFW300-CPDP)
- Profibus DPV1 (Not available)
- Profinet (Not available)
- CANopen (with accessory: CFW300-CCAN)
- DeviceNet (with accessory: CFW300-CCAN)
- EtherNet/IP (with accessory: CFW300-CETH)
- EtherCAT (Not available)
- Bluetooth (with accessory: CFW300-CBLT)
- BACnet (with accessory: CFW300-CRS485)

Available protection

- Output phase-phase overcurrente/Short
- Not applicable
- Under/Overvoltage in power
- Heat sink overtemperature
- Motor overload
- Not applicable
- Fault/External alarm
- Programming error
- CPU or memory failure

Operation interface (HMI)

- Availiability : Included in the product
- HMI installation : Fixed HMI
- Number of HMI buttons : 4
- Display : Numeric LCD
- Indication accuracy : 10% of rated current
- Speed resolution : 0,1 Hz
- Standard HMI degree of protection : IP20
- HMI battery type : Not applicable
- HMI battery life expectancy : Not applicable
- Remote HMI type : Accessory CFW320-KHMIR
- Remote HMI frame : Not applicable
- Remote HMI degree of protection : IP54

Ambient conditions

- Enclosure : IP20

DATASHEET

Variable Speed Drives



Ambient conditions

Degree of pollution (EN50178 and UL508C) : 2 (EN50178 and UL508C)
 Temperature around the inverter: of 0 °C / 32 °F to 40 °C / 104 °F. For temperatures above the specified is necessary to apply current reduction of 2 % per °C of 40 (104) to 50 °C (122 °F).
 Relative humidity: 5% to 95% without condensation.

Sustainability policies

RoHS : Yes
 Conformal Coating : 3C2 (IEC 60721-3-3:2002)

Dimensions and weight

- Size : B
 - Height : 198.9 mm / 7.8 in
 - Width : 70 mm / 2.76 in
 - Depth : 158.4 mm / 6.2 in
 - Weight : 1,2 kg / 2.6 lb

Mechanical Installation

Mounting position : Surface or DIN rail
 Fixing screw : M4
 Tightening torque : 2 N.m / 1.48 lb.ft
 Allows side-by-side assembly : Yes, without derating
 Minimum spacing around the inverter:
 - Top : 35 mm / 1.38 in
 - Bottom : 50 mm / 1.97 in
 - Front : 40 mm / 1.57 in
 - Between inverters (IP20) : Not applicable

Electrical connections

Cable gauges and tightening torques:

	Recommended cable gauge	Recommended tightening torque
Power	1.5 mm ² (16 AWG)	0.8 N.m / 0.6 lb.ft
Braking	2.5 mm ² (14 AWG)	0.8 N.m / 0.6 lb.ft
Grounding	2.5 mm ² (14 AWG)	0.8 N.m / 0.6 lb.ft
Control	0.5 to 1.5 mm ² (20 to 14 AWG)	0.3 N.m / 0.22 lb.ft

Additional especifications

SoftPLC : Yes, incorporated
 Maximum breaking current : 11.8 A
 Minimum resistance for the brake resistor : 68 Ω
 Recommended fuse : FNH000-20K-A / null
 Recommended circuit breaker [6] : MPW40-3-U010

Standards

Safety	<ul style="list-style-type: none"> - UL61800-5-1 - Adjustable speed electrical power drive systems - Part 5-1: Safety requirements - electrical, thermal and energy. - UL 840 - Insulation coordination including clearances and creepage distances for electrical equipment. - EN 61800-5-1 - Safety requirements electrical, thermal and energy. - EN 50178 - Electronic equipment for use in power installations. - EN 60204-1-Safety of machinery. Electrical equipment of machines. Part 1: General requirements. Note: To have a machine in accordance with that standard, the manufacturer of the machine is responsible for the installation of an emergency-stop device and a network switching equipment. - EN 60146 (IEC 146) - Semiconductor converters. - EN 61800-2 - Adjustable speed electrical power drive systems - Part 2: General requirements - Rating specifications for low voltage adjustable frequency AC power drive systems. - UL61800-5-1 - Adjustable speed electrical power drive systems - Part 5-1: Safety requirements - electrical, thermal and energy.
Electromagnetic Compatibility	<ul style="list-style-type: none"> - EN 61800-3 - Adjustable speed electrical power drive systems - Part 3: EMC product standard including specific test methods. - EN 55011 - Limits and methods of measurement of radio disturbance characteristics of industrial, scientific and medical (ISM) radio-frequency equipment. - CISPR 11 - Industrial, scientific and medical (ISM) radio-frequency equipment - Electromagnetic disturbance characteristics - Limits and methods of measurement. - EN 61000-4-2 - Electromagnetic compatibility (EMC) - Part 4: Testing and measurement techniques - Section 2: Electrostatic discharge immunity test. - EN 61000-4-3 - Electromagnetic compatibility (EMC) - Part 4: Testing and measurement techniques - Section 3: Radiated, radio-frequency, electromagnetic field immunity test.

DATASHEET

Variable Speed Drives



Standards

	<ul style="list-style-type: none">- EN 61000-4-4 - Electromagnetic compatibility (EMC) - Part 4: Testing and measurement techniques - Section 4: Electrical fast transient/burst immunity test.- EN 61000-4-5 - Electromagnetic compatibility (EMC) - Part 4: Testing and measurement techniques - Section 5: Surge immunity test.- EN 61000-4-6 - Electromagnetic compatibility (EMC)- Part 4: Testing and measurement techniques - Section 6: Immunity to conducted disturbances, induced by radio-frequency fields.- With external filter only
Mechanical Construction	<ul style="list-style-type: none">- EN 60529 - degrees of protection provided by enclosures (IP code).- UL 50 - enclosures for electrical equipment.- IEC 60721-3-3 - classification of environmental conditions - part 3: classification of groups of environmental parameters and their severities - section 3: stationary use at weather protected locations level 3m4.- EN 60529 e UL 50

Certifications

- 1) Considering minimum impedance of 1%;
- 2) Motor power is orientative, valid for standard WEG Motors of IV poles. The correct sizing must be done according to the nominal current of the motor used, which must be less than or equal to the rated output current of the inverter;
- 3) Braking resistor is not included;
- 4) For operation with a switching frequency above nominal, apply derating to the output current (refer to the user manual).
- 5) Surface mounting, HD overload.
- 6) Only for electrical circuit protection. For protection of inverters, use aR fuses indicated.
- 7) Only with external filter.

1

2

3

4

5

6

A

B

C

D

E

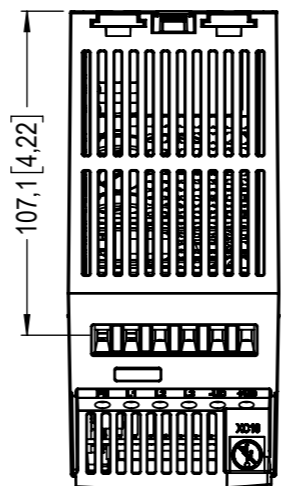
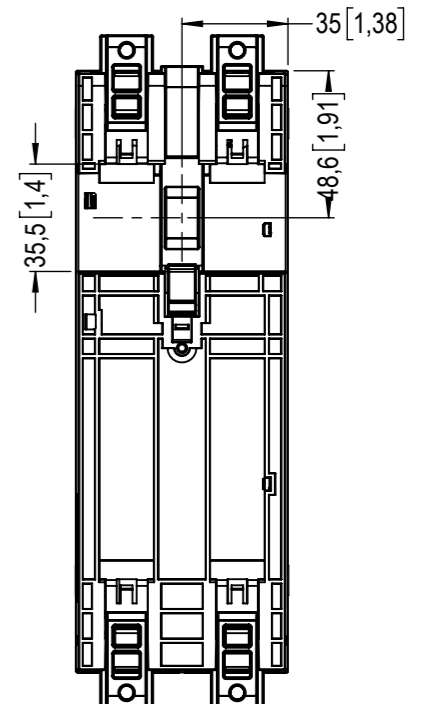
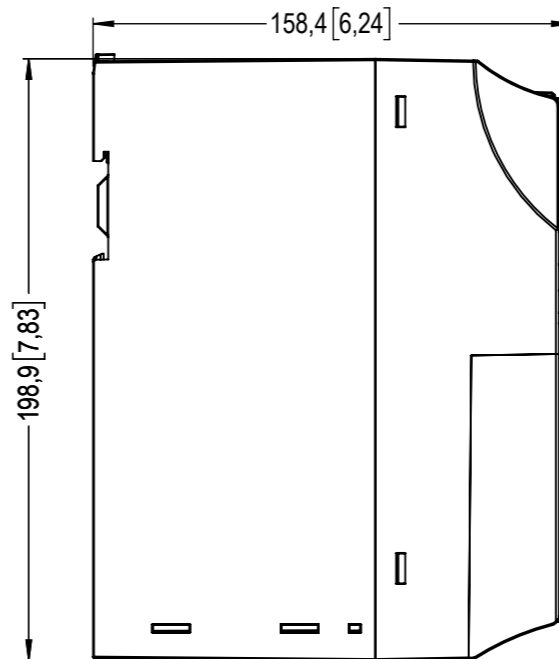
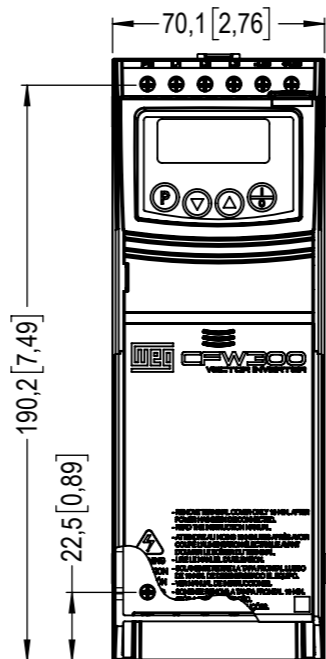
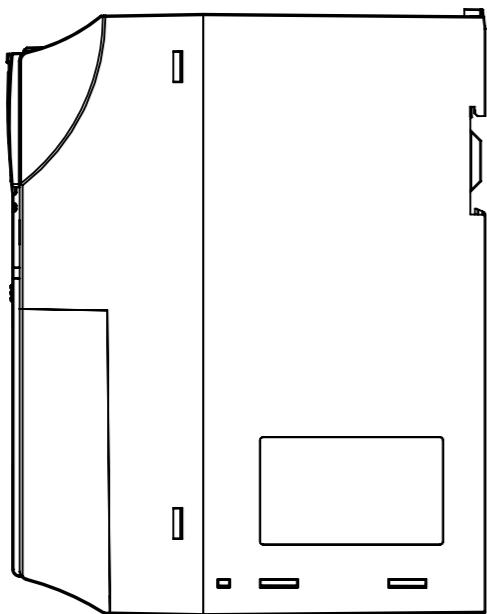
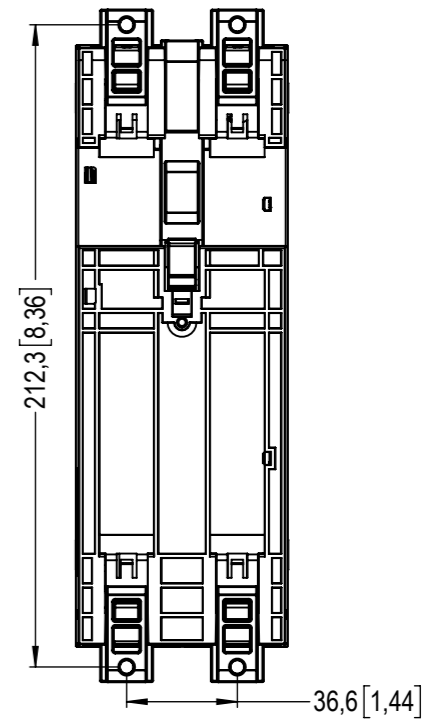
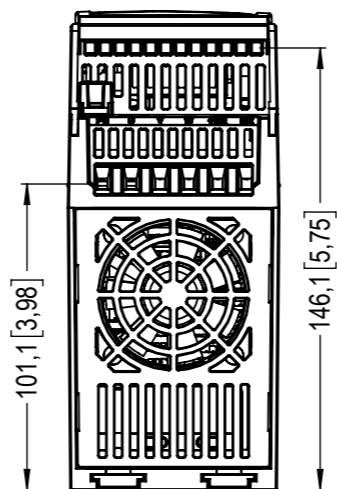
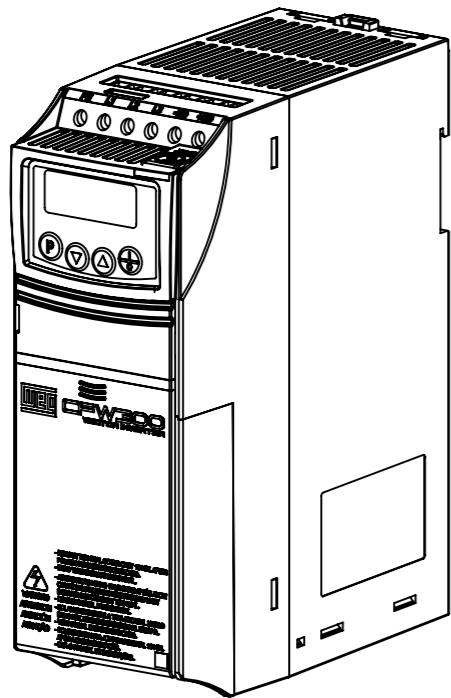

MASSA BRUTA/GROSS WEIGHT		kg	MASSA LÍQUIDA/NET WEIGHT		kg	ESCALA/SCALE				
ECM	LOC	RESUMO DE MODIFICAÇÕES SUMMARY OF MODIFICATIONS				EXECUTADO EXECUTED	VERIFICADO CHECKED	LIBERADO RELEASED	DATA DATE	VER
EXEC		CFW300 400v SIZE B				10005683096				
VERIF/CHECKED										
LIBER/RELEASED										
DT LIBER/REL DT						FOL/SHEET 1 / 1				